

FAG



Single row FAG X-life angular contact ball bearings

A Member of the
Schaeffler Group



Welcome to the Future! Unmatched Engineering Excellence. INA & FAG



Partner Power

X-life – this is the new premium grade from INA and FAG, offering you new opportunities for success. Benefit from the combined expertise of two rolling bearing manufacturers with a worldwide reputation – in every area of application covering automotive, machine building and precision engineering.

INA and FAG have brought together their strengths to give a new dimension in quality:

X-life.
Higher cost-effectiveness.
Higher operational security.

What X-life offers:

X-life offers excellent product quality that far exceeds previous standards.

Furthermore, X-life optimises all the parameters that are decisive for a problem-free production cycle. This includes correct fitting and dismantling, maintenance intervals matched to the specific application and the selection of lubricants matched to operating conditions.

A further convincing advantage of X-life is product characteristics that fulfil your specific requirements and offer additional benefits: for example, particularly low-noise, maintenance-friendly or high load capacity system solutions.

Your X-life advantages at a glance:

- product characteristics far above the norm
- lasting quality assurance and control
- extremely high reliability
- even greater security in planning and systems
- optimum availability
- smooth-running working processes
- reduced energy consumption
- the maximum possible cost-effectiveness
- the maximum possible level of service and support

Welcome to the Future!
Unmatched Engineering Excellence.
INA & FAG

FAG

A Member of the
Schaeffler Group

Single row FAG angular contact ball bearings

Expanded application · Advantages

Expanded application

High speeds and high axial loads are typical operating conditions in which single row angular contact ball bearings are used. In the case of application in pumps and compressors, there are frequently additional requirements such as high temperature resistance and low maintenance. In order to fulfil these demands reliably and economically, FAG is expanding its range of single row angular contact ball bearings.

The range now includes bearings with a versatile **sheet steel cage**, see section “Cages”, as well as **sealed bearings**.

Due to improvements in bearing kinematics and refined manufacturing processes, the new angular contact ball bearings are now classified as **X-life** products. This means a significantly improved price/performance ratio.

In addition to bearings with the cost-effective polyamide cage and bearings with the high-grade solid brass cage, we now also offer angular contact ball bearings with a versatile sheet steel cage.

Advantages of single row angular contact ball bearings

- **Higher performance bearing arrangements:**
X-life grade for significantly **longer operating life** (see page 2)
- **Lower operating costs:**
Improved bearing kinematics and higher raceway quality give reduced friction, lower bearing temperatures and lower lubricant requirement.
- **Proven in many applications**
e.g. in electrical machinery, pumps and compressors, ventilation plants, textile machinery, printing

machinery, gearboxes, metal-working machinery, machinery for the food processing sector

- **Standardised machine element** (DIN 628-1)
- **Suitability for high axial forces**
- **Suitability for high speeds**
- **Universal designs for versatile fitting in pairs**
- **Bearing designs for special requirements**, e.g.
for increased **operating temperatures**: metal cages (see section “Operating temperature range”),
for increased **running accuracy**, high **speed** and **smooth running**: bearings in tolerance class P5 (see section “Tolerances”),
for high **load carrying capacity** and high **rigidity**: preloaded pairs of universal bearings (see section “Preloading of bearings”)
- **New, sealed bearings**
for **maintenance-free, easy-to-fit, cost-effective bearing arrangements** (available by agreement)



Proven designs of single row angular contact ball bearings with a 40° contact angle; left: with polyamide cage, right: with brass cage



New bearing design with sheet steel cage

Single row FAG angular contact ball bearings

Operating life

Operating life

Long operating life and high reliability are the primary requirements, especially in the most frequent application of single row angular contact ball bearings in pumps and compressors. In this case, high loads occur together with high speeds. The lubrication conditions are often unfavourable and contamination can impair operating life.

X-life angular contact ball bearings are matched to these conditions. They offer high load carrying capacity and are especially suitable for high speeds, since they generate little heat and place only low demands on lubrication. In the sealed designs, the high cleanliness of the rolling contacts is maintained – a precondition for a long bearing life.

Expanded adjusted rating life

Since the basic rating life in accordance with ISO 281 only rarely indicates the actually achievable running time, a method for determining the expanded adjusted rating life was developed in Appendix 1 of ISO 281. This takes account of significant influences on the life, namely

- the separation of surfaces by the lubricant film,
- the influences of agents (additives) in the lubricant,
- cleanliness in the lubrication gap,
- the level of bearing load,
- the type of bearing.

Calculation of the expanded adjusted rating life

The calculation method described in ISO 281 Appendix 1:2003-4 for determining the expanded adjusted rating life was derived from the methods used by several rolling bearing manufacturers.

The expanded adjusted rating life is determined from

$$L_{nm} = a_1 \times a_{DIN} \times L \text{ [} 10^6 \text{ revolutions]}$$

and

$$L_{hnm} = a_1 \times a_{DIN} \times L_h \text{ [h]}$$

where

- a_1 Adjustment factor for requisite reliability
- a_{DIN} Adjustment factor for operating conditions
- L Basic rating life [10^6 revolutions]
- L_h Basic rating life [h]

If the influences change during the operating period, the L_{hnm} value and the resultant total rating life must be determined for each period during which conditions are constant.

Factor a_1 for requisite reliability

Rolling bearing failures as a result of fatigue are subject to statistical laws; the requisite reliability must therefore be taken into consideration when calculating the fatigue limit life. Normally, calculation is carried out on the basis of 90 % requisite reliability (corresponding to 10 % failure probability). The L_{10} life is the basic rating life.

In order to take account of requisite reliabilities between 90 and 99 %, the factor a_1 is used, see the following table.

Factor a_1						
Requisite reliability %	90	95	96	97	98	99
Factor a_1	1	0.62	0.53	0.44	0.33	0.21

Life adjustment factor a_{DIN}

The standardised calculation method for determining a_{DIN} takes account of the following influences:

- the bearing load
- the lubrication condition (type and viscosity of the lubricant, additives, speed, bearing size)
- the fatigue limit of the material
- the type of bearing
- the environmental conditions (contamination of the lubricant)

$$a_{DIN} = f(e_c \times C_u / P, \kappa)$$

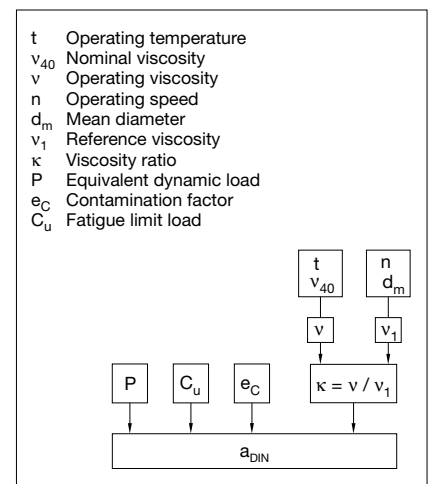

System for determining a_{DIN}

Single row FAG angular contact ball bearings

Operating life

Viscosity ratio κ

The viscosity ratio κ indicates the quality of lubricant film formation. κ is the ratio between the viscosity v of the lubricant at operating temperature and the reference viscosity v_1 :

$$\kappa = v/v_1$$

The reference viscosity v_1 is determined from the left hand diagram using the mean bearing diameter $d_m = (D + d)/2$ and the operating speed n .

The operating viscosity v of an oil is derived from the V-T diagram using the operating temperature t and the (nominal) viscosity of the oil at +40 °C.

For greases, v is taken as the operating viscosity of the base oil. For recommendations on oil viscosity and oil selection, see Catalogue WL 41 520.

In the case of bearings under high loads with large proportional sliding areas, the temperature in the contact area of the rolling elements can be up to 20 K higher than that of the temperature measured on the stationary ring (excluding the influence of external heat sources).

Contamination factor e_c

If the lubricant is contaminated with particles, permanent indentations may be caused in the raceways by overrolling of these particles. Local increases in stress occur at these indentations which reduce the life of the rolling bearing. This is taken into consideration by the contamination factor e_c . Guide values for e_c : see the following table. The reduction in the life as a result of solid particles in the lubrication

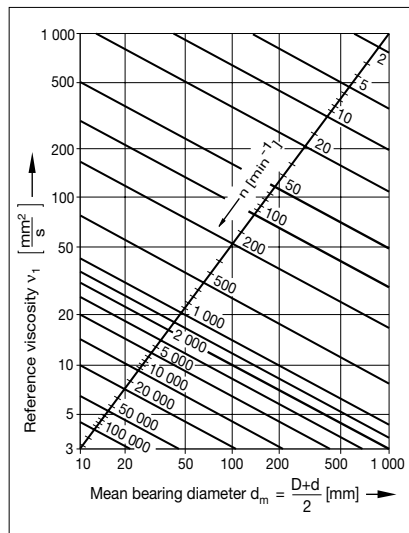

Reference viscosity v_1

gap is dependent on

- the type, size, quantity and hardness of the particles
- the lubricant film thickness (viscosity ratio κ)
- the bearing size

The stated values are valid for contamination by solid particles.

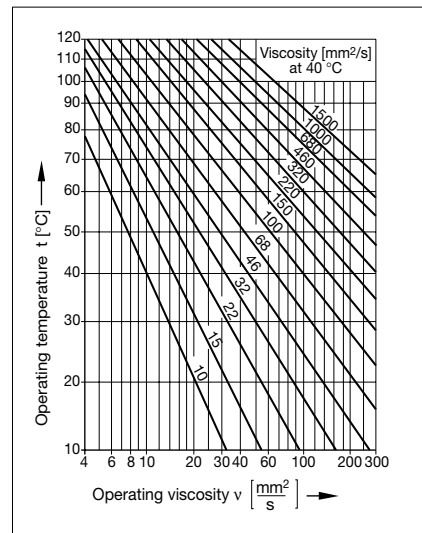

V-T diagram for mineral oils

Other types of contamination, for example by water or other liquids, cannot be taken into consideration in this way.

If severe contamination is present ($e_c \rightarrow 0$), failure due to wear must be expected; the operating life of the bearing is then far less than the calculated rating life.

Contamination factor e_c

Degree of contamination

Degree of contamination	Factor e_c	
	$d_m < 100 \text{ mm}$	$d_m \geq 100 \text{ mm}$
Extreme cleanliness Particle size within lubricant film thickness Laboratory conditions	1	1
High cleanliness Very fine filter in oil feed Sealed, greased bearings	0.8 to 0.6	0.9 to 0.8
Normal cleanliness Fine filter in oil feed Greased bearings with sealing shields	0.6 to 0.5	0.8 to 0.6
Slight contamination Slight contamination in oil feed	0.5 to 0.3	0.6 to 0.4
Typical contamination Bearing contaminated with abraded material from other machine elements	0.3 to 0.1	0.4 to 0.2
Heavy contamination Heavily contaminated bearing environment Inadequate sealing of bearing arrangement	0.1 to 0	0.1 to 0
Very heavy contamination	0	0

d_m Mean bearing diameter; $d_m = (D + d)/2$

Single row FAG angular contact ball bearings

Operating life

Fatigue limit load C_u

In accordance with ISO 281/A2, the life adjustment factor a_{xyz} is stated as a function of the ratio between the fatigue limit of the raceway material σ_u and the fatigue-relevant stress σ .

The fatigue-relevant stress in the raceway is dependent principally on the internal load distribution in the bearing and the stress curve in the rolling contact under the heaviest load. Under ideal contact conditions, the fatigue limit of conventional rolling bearing steels is reached at a Hertzian pressure of approx. 2200 N/mm².

In order to aid practical calculation, the fatigue limit load C_u has been introduced. The calculation of C_u in ISO 281 Appendix 1 is based on a contact pressure of 1500 N/mm². On the same basis as the basic static load rating C_0 in accordance with ISO 76, C_u is defined as the load under which the fatigue limit of the bearing material is reached at the contact under the heaviest load. A good approximation of the ratio σ_u/σ can therefore be determined as a function of C_u/P .

When determining C_u , the following must be taken into consideration:

- the type, size and internal geometry of the bearing
- the profiling of the rolling elements and raceways
- the quality of manufacture
- the fatigue limit of the material

Due to the higher profile accuracy of the raceways and the better surface quality of the X-life angular contact ball bearings, C_u can be increased by more than 30 %. This leads to an increase of up to 50 % in the life, as shown in the diagram for a_{DIN} .

Values for the fatigue limit load are given in the dimension tables for each X-life angular contact ball bearing.

Taking account of EP additives

At a viscosity ratio $\kappa < 1$ and a contamination factor $e_c \geq 0.2$, the value $\kappa = 1$ can be assumed when using lubricants with proven effective EP additives. If heavy contamination is present (contamination factor $e_c < 0.2$), the

effectiveness of the additives must be demonstrated under these contamination conditions. Evidence of the effectiveness of the EP additives can be obtained in the actual application or by means of a rolling bearing test rig FE 8 to DIN 51819-1.

If the EP additives are proven to be effective and the value $\kappa = 1$ is assumed, the life adjustment factor must be restricted to $a_{DIN} \leq 3$. If the calculated value $a_{DIN}(\kappa)$ for the actual κ is larger than 3, this value can be assumed.

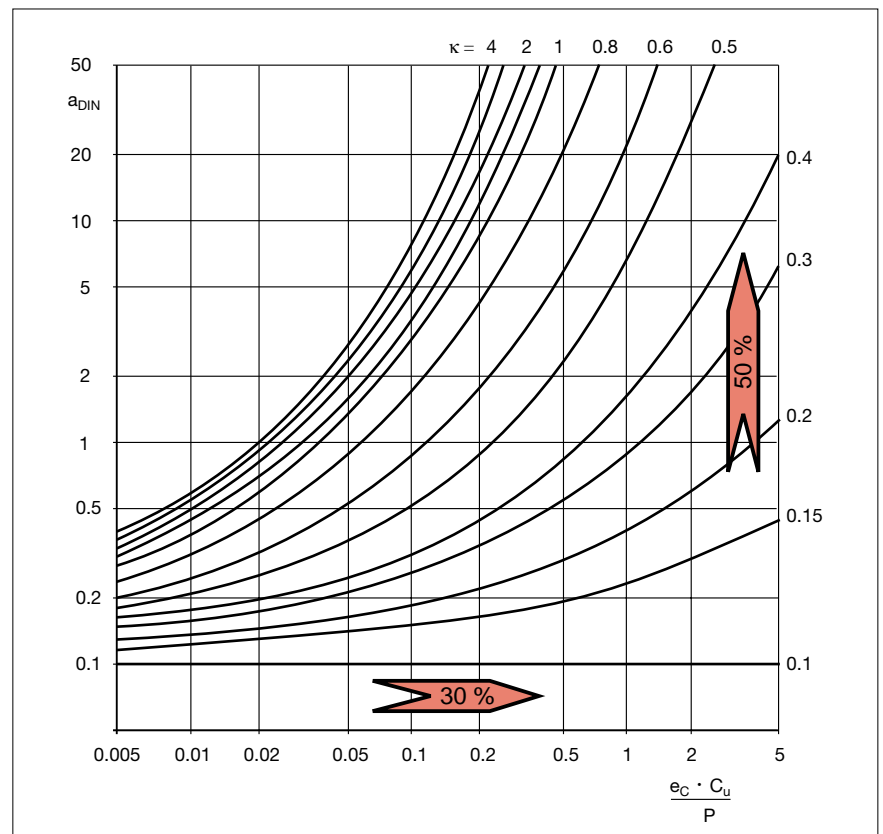

Life adjustment factor a_{DIN} for X-life angular contact ball bearings
If $\kappa > 4$, assume $\kappa = 4$. Not to be used for $\kappa < 0.1$

Single row FAG angular contact ball bearings

Load carrying capacity · Minimum load · Basic load ratings for matched bearings · Equivalent dynamic and static load · Axial force for single bearing

Load carrying capacity

In single row angular contact ball bearings, the raceways are arranged such that the forces are transmitted from one raceway to another at a certain contact angle. Due to their large contact angle of 40°, bearings of series 70B, 72B and 73B are suitable for high axial forces. The bearings can only transmit radial forces if they are subjected to axial load at the same time. Normally, a bearing is adjusted against a second angular contact ball bearing in a mirror image arrangement.

Minimum load

If insufficient loading is present, slippage can occur in the bearing. The overriding critical factor is slippage collapse.

The lubricant film at the contact points is broken and the rolling surfaces come into contact at a high relative speed. The functional surfaces may be damaged by smearing or micropitting. We recommend that angular contact ball bearings should be subjected to at least 1 % of their basic dynamic load rating C.

Basic dynamic load rating C for matched bearings

Group of i angular contact ball bearings of identical size and design:

$$C = i^{0.7} \times C_{\text{Single bearing}} \text{ [kN]}$$

Basic static load rating C₀ for two matched bearings

$$C_0 = 2 \times C_{0 \text{ Single bearing}} \text{ [kN]}$$

Equivalent dynamic load

Single bearing:

$$P = F_r \quad \text{for } F_a/F_r \leq 1.14$$

$$P = 0.35 F_r + 0.57 F_a \quad \text{for } F_a/F_r > 1.14$$

Bearing pair in O or X arrangement:

$$P = F_r + 0.55 F_a \quad \text{for } F_a/F_r \leq 1.14$$

$$P = 0.57 F_r + 0.93 F_a \quad \text{for } F_a/F_r > 1.14$$

Equivalent static load

Single bearing:

$$P_0 = F_r \quad \text{for } F_a/F_r \leq 1.9$$

$$P_0 = 0.5 F_r + 0.26 F_a \quad \text{for } F_a/F_r > 1.9$$

Bearing pair in O or X arrangement:

$$P_0 = F_r + 0.52 F_a$$

Determining the axial force for the single bearing

Due to the inclined raceways, a radial load generates axial reaction forces in angular contact ball bearings that must be taken into consideration when determining the equivalent load. The axial force is calculated using the formulae in the following table. The bearing supporting the external axial force K_a – independent of the axial reaction forces – is designated as bearing “A” while the other bearing is designated as bearing “B”. For bearings of series 70B, 72B and 73B, the value $Y = 0.57$ is used in the formulae.

If no formulae are given, the axial force F_a is not taken into consideration in calculation.

	A	B	
Load conditions			Axial force F_a to be used in calculation of the equivalent dynamic load
	Bearing A	Bearing B	
$\frac{F_{rA}}{Y_A} \leq \frac{F_{rB}}{Y_B}$	$F_a = K_a + 0.5 \times \frac{F_{rB}}{Y_B}$	–	
$\frac{F_{rA}}{Y_A} > \frac{F_{rB}}{Y_B}$	$F_a = K_a + 0.5 \times \frac{F_{rB}}{Y_B}$	–	
$K_a > 0.5 \times \left(\frac{F_{rA}}{Y_A} - \frac{F_{rB}}{Y_B} \right)$			
$\frac{F_{rA}}{Y_A} > \frac{F_{rB}}{Y_B}$	–	$F_a = 0.5 \times \frac{F_{rA}}{Y_A} - K_a$	
$K_a \leq 0.5 \times \left(\frac{F_{rA}}{Y_A} - \frac{F_{rB}}{Y_B} \right)$			

Single row FAG angular contact ball bearings

Cages

Cages

Angular contact ball bearings up to 130 mm bore diameter have as standard a solid window cage made from glass fibre-reinforced polyamide 66 (suffix TVP). This economical cage is also used for sealed angular contact ball bearings.

As standard, bearings with a bore code of 24 or higher have a high-quality solid window cage made from brass (suffix MP).

The range is supplemented by a universally applicable window cage made from sheet steel (JP).

Advantages of the sheet steel cage:

- Insensitive to synthetic lubricant
- Continuous temperature up to 200 °C (for $D \leq 240$ mm, in conjunction with heat treatment to S1)
- Longer grease operating life

Features and availability of cages for single row FAG angular contact ball bearings

Designation	Design	Suffix	Speed parameter	Features	Availability		
					70B	72B	73B
					Bore code		
Polyamide cage	Solid window cage, rolling element guided	TVP	< 550 000	Low mass, more favourable price, low noise	04 to 08	00 to 20, 22 to 26	01 to 20, 22 to 26
Sheet steel cage	Window cage, rolling element guided	JP	< 550 000	Insensitive to synthetic oils, large space for lubricant, low mass, universal cage		00 to 20, 22	01 to 20 22
Brass cage	Solid window cage, rolling element guided	MP	< 900 000	Good speed suitability, high strength		00 to 30	01 to 26

Single row FAG angular contact ball bearings

Suitability for high speeds · Operating temperature range

Suitability for high speeds

The limiting speeds takes into consideration the mechanical limits such as the strength of the bearing parts, the churning friction of the grease or the permissible sliding speed of contact seals. Grease-filled, sealed angular contact ball bearings have a lower speed suitability than comparable open bearings.

Speed suitability of bearing pairs

The permissible operating speed for bearing pairs of universal designs UA and UO in X, O and tandem arrangements is about 20 % below the permissible value for the single bearing. This is in order to prevent internal distortion of bearing pairs as a result of the unfavourable thermal balance.

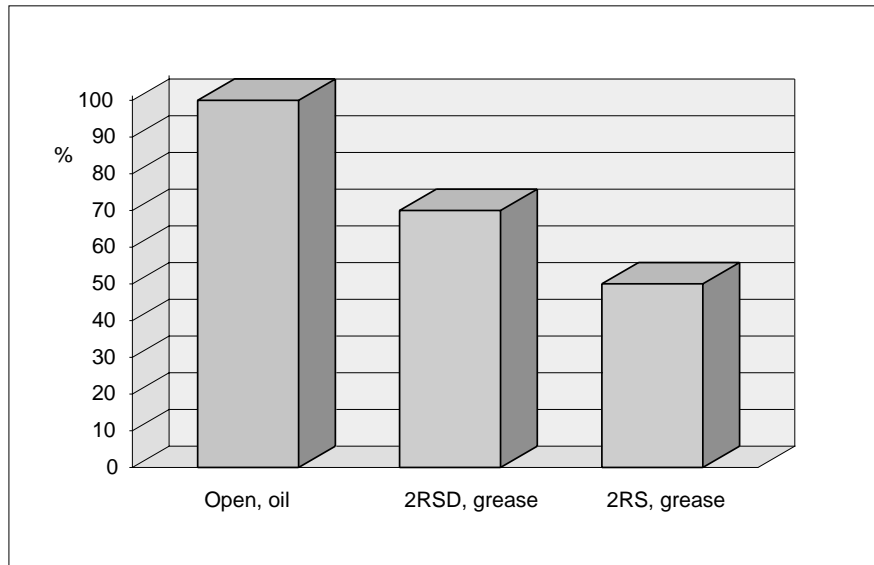

Limiting speeds for various designs of angular contact ball bearings

Operating temperature range

Angular contact ball bearings are heat treated such that they can be used up to an operating temperature of +150 °C. Bearings over 240 mm outside diameter are dimensionally stable up to +200 °C. In the case of bearings with plastic cages and sealed bearings, attention must be paid to the operating temperature limit of the cage or seal material respectively.

Operating temperature range for angular contact ball bearings

Open angular contact ball bearings with sheet steel cage or brass cage

Open angular contact ball bearings with polyamide cage

Sealed angular contact ball bearings with polyamide cage and seal (RSD or RS) + standard grease

Permissible continuous temperatures

Lower limit range

Dependent on lubricant

-40 °C

-30 °C
(-40 °C for short periods)

Upper limit range

+150 °C
(D ≤ 240 mm)
+200 °C
(D > 240 mm)

+120 °C
dependent on lubricant

+80 °C
(+120 °C
dependent on lubricant)

Single row FAG angular contact ball bearings

Tolerances · Universal design · Preloading · Matched bearing sets ·
Tolerances of universal design and matched bearings · Angular adjustment facility

Tolerances

FAG angular contact ball bearings are generally manufactured to normal tolerance PN. By agreement, we also supply bearings with increased accuracy to tolerance class P5.

Universal design

Single row angular contact ball bearings of universal design are suitable for mounting in pairs in an X, O or tandem arrangement. These bearings can be fitted in any arrangement required. Sealed single row angular contact ball bearings of universal design are suitable for fitting in an X or O arrangement. For tandem arrangements, please consult FAG. The following distinction is to be made in X or O arrangements:
 UA Slight axial internal clearance
 UO Clearance-free
 UL Slight preload
 Values for axial internal clearance and preload: see table on page 9.

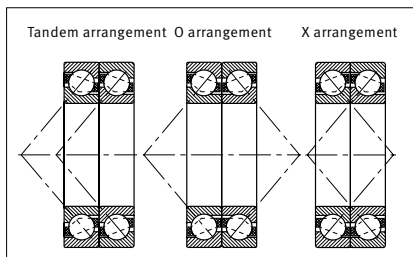

Preloading of bearings

Through lateral sizing of the single bearings, the axial clearance or preload of the bearing pair can be adjusted to the required value.

Advantages of preloaded bearings:

- Higher bearing rigidity
- Lower running noise
- More precise guidance
- Reliable minimum load

Matched bearing sets

FAG supplies matched bearing sets in accordance with specification N10 by agreement. When ordering, the number of bearing sets must be stated, not the number of single bearings.

Tolerances of the universal design and matched bearings

Angular contact ball bearings of universal design UO or UA are supplied to normal tolerance PN (no suffix for tolerance) and by agreement with increased accuracy to tolerance class P5. For angular contact ball bearings of universal design, the tolerances for normal radial bearings apply.

Exceptions: Bore tolerances for bearings to tolerance classes PN and P5 uniformly to P5 (no special suffix). The ring width tolerance for universal bearings and matched bearings is given in the following table.

Angular adjustment facility

The angular adjustment facility of single row angular contact ball bearings is dependent on several factors (e.g. load, speed, direction of tilting, cage type, bearing size, bearing arrangement, accuracy of bearing seats etc.) and influences the bearing performance (e.g. rigidity, load carrying capacity etc.) in various ways so it is not possible to make a generally valid statement. A guide value for the possible skewing of single bearings can be taken as approx. 2 angular minutes.

Ring width tolerance for universal bearings and matched bearings

Nominal dimension for bearing bore	over incl.	Dimensions in mm				
		50	80	120	180	315
Width deviation Δ_{B_s} [μm]						
Tolerance class	PN	0	0	0	0	0
		-250	-380	-380	-500	-500
P5		0	0	0	0	0
		-250	-250	-380	-380	-500

Single row FAG angular contact ball bearings

Axial internal clearance and preloading of bearing pairs

Axial internal clearance and preload for angular contact ball bearings of universal design fitted in X and O arrangements

Bore code	Axial internal clearance or preload of bearing pair					Preload force (UL)		
	Nominal dimension [μm]					F _v [N] max.		
	UA	UO	UL	72B	73B	UL	72B	73B
	70B, 72B, 73B			70B	72B	73B	70B	72B
Tolerance classes					Tolerance class			
PN, P6, P5					P5	P5	P5	P5
00	22	0		-3			38	
01	24	0		-4	-5		53	82
02	24	0		-4	-5		62	99
03	24	0		-4	-6		77	123
04	28	0	-4	-5	-6	103	103	146
05	34	0	-4	-4	-6	115	112	200
06	34	0	-5	-5	-7	141	157	250
07	40	0	-5	-6	-7	172	208	300
08	40	0	-5	-6	-8	200	246	385
09	44	0		-6	-9		277	462
10	44	0		-6	-10		288	535
11	46	0		-7	-10		358	600
12	46	0		-7	-10		431	692
13	46	0		-8	-11		492	785
14	50	0		-8	-11		535	877
15	50	0		-8	-12		523	977
16	50	0		-8	-12		615	1077
17	54	0		-8	-13		692	1154
18	54	0		-9	-13		815	1231
19	54	0		-10	-14		892	1331
20	54	0		-11	-14		992	1485
21	58	0		-11	-14		1100	1538
22	58	0		-12	-15		1177	1723
24	58	0		-12	-16		1277	1923
26	60	0		-12	-17		1431	2115
28	60	0		-12			1508	
30	60	0		-13			1723	

Tolerances for axial internal clearance and preload for angular contact ball bearings of universal design fitted in pairs in X and O arrangements [μm]

Bore code	Series 70B, 72B		Series 73B		
	Tolerance classes	PN, P6	P5	PN, P6	P5
00 to 09		+8	+6	+8	+6
10 and 11		+8	+6	+12	+10
12 to 34		+12	+10	+12	+10

Single row FAG angular contact ball bearings

Sealed bearings

Sealed angular contact ball bearings

FAG angular contact ball bearings lubricated for life are fitted with seals. Matching the lubrication and sealing to each other gives the best conditions for a long operating life.

Further advantages:

- Grease filling with tested FAG grease in the right quantity
- No risk of contamination during operation and fitting
- No impermissible mixing of grease e.g. during relubrication
- Costs for external sealing, relubrication devices and grease stockholding are eliminated

FAG angular contact ball bearings are available with seals on one or both sides. In the case of bearings sealed on one side, it is indicated in the designation whether the seal is on the outside in an O or X arrangement.

Lubrication

During manufacture, sealed FAG angular contact ball bearings are filled with a quality grease tested in accordance with FAG specifications, see TI WL 43-1191, page 16. The standard grease is suitable for continuous temperature up to +80 °C and considerably exceeds the requirements of DIN 51825.

The bearings are protected against wear and premature fatigue as well as against corrosion. The grease has a noise-damping effect.

The permissible continuous temperature can be increased to +120° C by the use of a special grease.

Design of sealing washers

The sealing washers are of different designs on the two sides of the bearing.

Since the grease in the angular contact ball bearing migrates

particularly strongly to the inner ring rib having the largest diameter, a more costly design is used there. The seal in the stepped slot gives significantly better grease retention capacity.

A normal sealing washer is fitted on the side with the small inner ring rib.

Contact sealing washers (RS)

Single row FAG angular contact ball bearings with RS seals are suitable for sealing against dust, contamination, damp atmospheres and slight pressure differences (< 0.5 bar).

In the case of the RS design, the speed is limited by the permissible sliding speed of the seal lips.

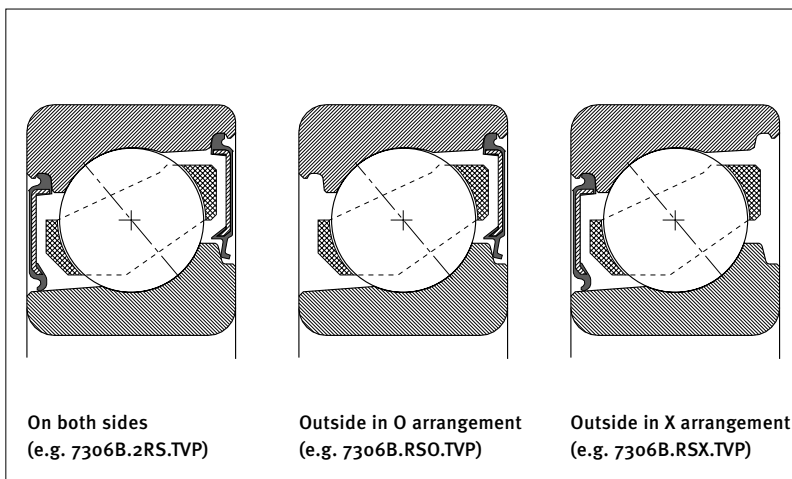

Contact sealing washers

Single row FAG angular contact ball bearings

Sealed bearings

Non-contact sealing washers

After running in, bearings with RSD seals and a minimal seal gap (supplied by agreement) have a low friction value equal to that of open bearings.

Sealing shields

FAG angular contact ball bearings with non-contact sealing shields are available by agreement.

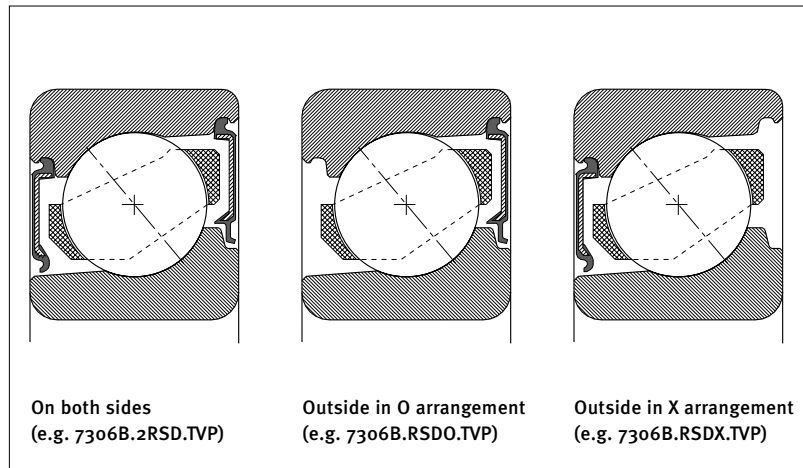

Non-contact sealing washers

Features and availability of seals for single row FAG angular contact ball bearings

Designation	Design	Suffix	Speed parameter $n \times d_m$ [min ⁻¹ × mm]	Features	Availability		
					70B Bore code	72B	73B
Sealing washer contact	Both sides	2RS	< 300 000	Sealing against dust, contamination, damp atmosphere	04 to 08	00 to 08	02 to 06, 08
	One side, outside in O arrangement	RSO					
	One side, outside in X arrangement	RSX					
Sealing washer non-contact	Both sides	2RSD	< 550 000	Low friction, also suitable with rotating outer ring			05, 06, 08
	One side, outside in O arrangement	RSDO					
	one side, outside in X arrangement	RSDX					

Single row FAG angular contact ball bearings

Ordering designation · Suffixes

Ordering designation for FAG angular contact ball bearings

Ordering example:

Bearing designation	Normal design
Seal	Sealing washer (RSO, contact)
Cage	Polyamide cage (TVP)
Universal design	Axial internal clearance 34 µm (see page 9)

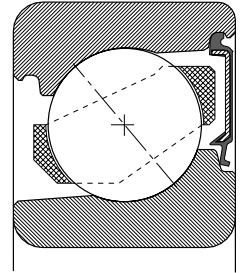
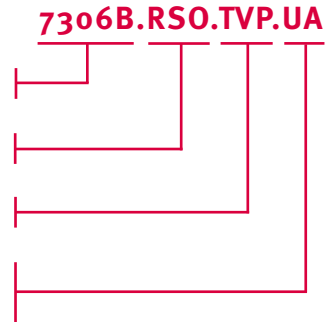

Suffixes

B Angular contact ball bearing with 40° contact angle

Sealing

- 2RS** Sealing washers on both sides
- RSO** Sealing washer (outside in O arrangement)
- RSX** Sealing washer (outside in X arrangement)
- 2RSD** Non-contact sealing washers on both sides
- RSDO** Non-contact sealing washer (outside in O arrangement)
- RSDX** Non-contact sealing washer (outside in X arrangement)
- 2Z** Sealing shields on both sides
- ZO** Sealing shield (outside in O arrangement)
- ZX** Sealing shield (outside in X arrangement)

Cage

- JP** Sheet steel window cage, rolling element guided
- MP** Brass solid window cage, rolling element guided
- TVP** Solid window cage made from glass fibre reinforced polyamide, rolling element guided

Tolerance

- P5** Tolerance class P5
- P6** Tolerance class P6

Universal design

- UA** Universal design for fitting in pairs, bearing pair has slight axial internal clearance in O and X arrangements
- UL** Universal design for fitting in pairs, bearing pair has slight preload in O and X arrangements
- UO** Universal design for fitting in pairs, bearing pair is clearance-free in O and X arrangements

Single row FAG angular contact ball bearings

X-life

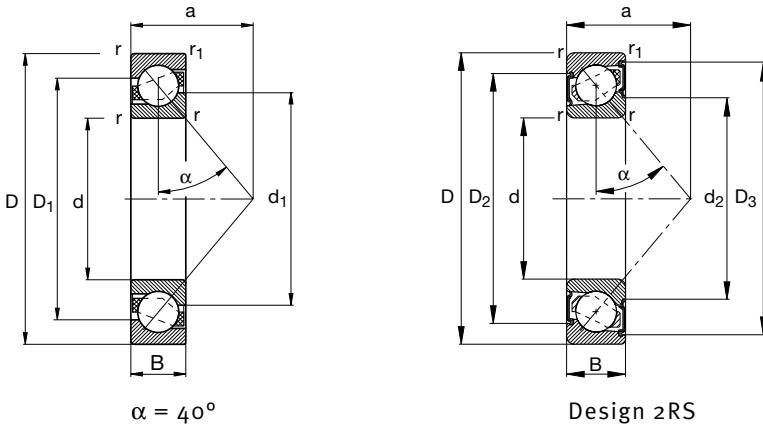

Single row FAG angular contact ball bearings, d = 10–17 mm

Shaft	Dimensions											Mass ≈ kg	Basic load ratings	
	d	D	B	r	r ₁	a	D ₁	D ₂	D ₃	d ₁	d ₂		dynam. C _r	stat. C _{0r}
	mm												N	
10	10	30	9	0.6	0.3	13	22.1				18	0.032	5000	2500
	10	30	9	0.6	0.3	13	22.1				18	0.033	5000	2500
	10	30	9	0.6	0.3	13	22.1				18	0.036	5000	2500
	10	30	9	0.6	0.3	13	22	23.3	25.6	18.3	15.5	0.032	5000	2500
12	12	32	10	0.6	0.3	14	24.6				19.5	0.035	6950	3400
	12	32	10	0.6	0.3	14	24.6				19.5	0.038	6950	3400
	12	32	10	0.6	0.3	14	24.6				19.5	0.039	6950	3400
	12	32	10	0.6	0.3	14	24.6	25.9	28.8	19.8	17	0.037	6950	3400
	12	37	12	1	0.6	16	27.2				22.1	0.06	10600	5000
	12	37	12	1	0.6	16	27.2				22.1	0.066	10600	5000
	12	37	12	1	0.6	16	27.2				22.1	0.066	10600	5000
15	15	35	11	0.6	0.3	16	27.6				22.5	0.044	8000	4300
	15	35	11	0.6	0.3	16	27.6				22.5	0.047	8000	4300
	15	35	11	0.6	0.3	16	27.6				22.5	0.051	7500	3900
	15	35	11	0.6	0.3	16	27.6	29.2	32.1	22.8	19.7	0.044	8000	4300
	15	42	13	1	0.6	18	31.8				25.5	0.082	12900	6550
	15	42	13	1	0.6	18	31.8				25.5	0.088	12900	6550
	15	42	13	1	0.6	18	31.8				25.5	0.089	12000	5850
	15	42	13	1	0.6	18	31.7	33.3	38.1	26	22.9	0.082	12900	6550
17	17	40	12	0.6	0.6	18	31.2				26.2	0.065	10000	5500
	17	40	12	0.6	0.6	18	31.2				26.2	0.069	10000	5500
	17	40	12	0.6	0.6	18	31.2				26.2	0.071	9300	5000
	17	40	12	0.6	0.6	18	31.5	33.1	36.3	26	22.9	0.065	10000	5500
	17	47	14	1	0.6	20	35.8				28.5	0.109	16000	8300
	17	47	14	1	0.6	20	35.8				28.5	0.117	16000	8300
	17	47	14	1	0.6	20	35.8				28.5	0.119	15000	7350
	17	47	14	1	0.6	20	35.5	37.2	42.6	29.2	26.1	0.109	16000	8300

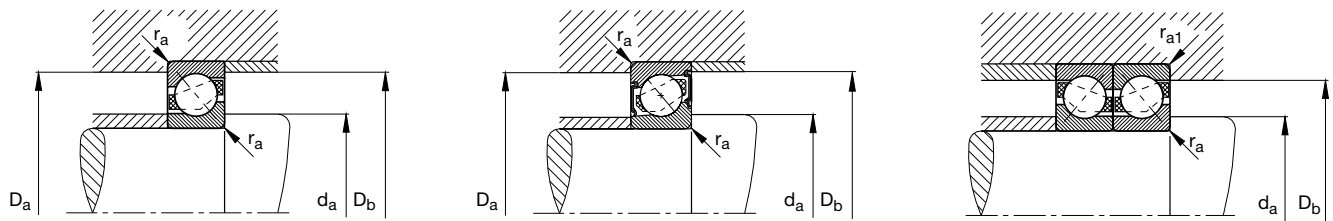

Fatigue limit load C_{ur} N	Limiting speed min^{-1}	Reference speed	Designation Bearing FAG	Mounting dimensions				
				d_a min mm	D_a max	D_b max	r_a max	r_{a1} max
177	32000	26000	7200B.TVP	14.2	25.8	27.6	0.6	0.3
177	32000	26000	7200B.JP	14.2	25.8	27.6	0.6	0.3
177	50000	26000	7200B.MP	14.2	25.8	27.6	0.6	0.3
177	15000		7200B.2RS.TVP	14.2	25.8	27.6	0.6	0.3
242	28000	26000	7201B.TVP	16.2	27.8	29.6	0.6	0.3
242	28000	26000	7201B.JP	16.2	27.8	29.6	0.6	0.3
242	45000	26000	7201B.MP	16.2	27.8	29.6	0.6	0.3
242	14000		7201B.2RS.TVP	16.2	27.8	29.6	0.6	0.3
360	24000	19000	7301B.TVP	17.6	31.4	32.8	1	0.6
360	24000	19000	7301B.JP	17.6	31.4	32.8	1	0.6
360	38000	19000	7301B.MP	17.6	31.4	32.8	1	0.6
305	24000	22000	7202B.TVP	19.2	30.8	32.6	0.6	0.3
305	24000	22000	7202B.JP	19.2	30.8	32.6	0.6	0.3
275	38000	22000	7202B.MP	19.2	30.8	32.6	0.6	0.3
305	24000		7202B.2RS.TVP	19.2	30.8	32.6	0.6	0.3
485	20000	17000	7302B.TVP	20.6	36.4	37.8	1	0.6
485	20000	17000	7302B.JP	20.6	36.4	37.8	1	0.6
435	32000	17000	7302B.MP	20.6	36.4	37.8	1	0.6
485	11000		7302B.2RS.TVP	20.6	36.4	37.8	1	0.6
390	20000	20000	7203B.TVP	21.2	35.8	35.8	0.6	0.6
390	20000	20000	7203B.JP	21.2	35.8	35.8	0.6	0.6
350	32000	20000	7203B.MP	21.2	35.8	35.8	0.6	0.6
390	11000		7203B.2RS.TVP	21.2	35.8	35.8	0.6	0.6
610	18000	15000	7303B.TVP	22.6	41.4	42.8	1	0.6
610	18000	15000	7303B.JP	22.6	41.4	42.8	1	0.6
550	28000	15000	7303B.MP	22.6	41.4	42.8	1	0.6
610	13000		7303B.2RS.TVP	22.6	41.4	42.8	1	0.6

Other designs are also available; please contact us.

Single row FAG angular contact ball bearings

X-life

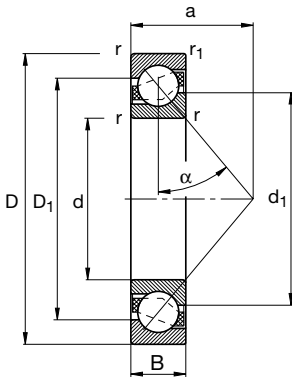

$\alpha = 40^\circ$

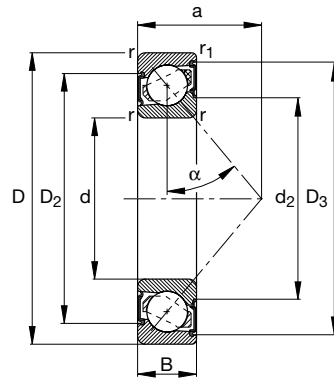

Design 2RS

Single row FAG angular contact ball bearings, $d = 20-30$ mm

Shaft	Dimensions											Mass ≈ kg	Basic load ratings	
	d	D	B	r min	r ₁ min	a ≈	D ₁ ≈	D ₂ ≈	D ₃ ≈	d ₁ ≈	d ₂ ≈		dyn. C _r	stat. C _{or}
	mm												N	
20	20	42	12	0.6	0.3	11.6	34.7				29.1	0.06	13400	7500
	20	42	12	0.6	0.3	11.6	35.4	37.1	40.9	28.9	25.9	0.061	13400	7500
	20	47	14	1	0.6	21	36.6			30.4		0.104	13400	7650
	20	47	14	1	0.6	21	36.6			30.4		0.111	13400	7650
	20	47	14	1	0.6	21	36.6			30.4		0.118	13400	7650
	20	47	14	1	0.6	21	37	39.1	43	30.5	26.8	0.108	13400	7650
	20	52	15	1.1	0.6	23	39.9			32.4		0.143	19000	10400
	20	52	15	1.1	0.6	23	39.9			32.4		0.152	19000	10400
	20	52	15	1.1	0.6	23	39.9			32.4		0.156	17600	9500
	20	52	15	1.1	0.6	23	39.7	41.4	47.1	33	30	0.143	19000	10400
25	25	47	12	0.6	0.3	21	39.7			34.1		0.071	15000	9300
	25	47	12	0.6	0.3	21	39.8	41.5	45.9	33.9	30.9	0.071	15000	9300
	25	52	15	1	0.6	24	41.6			35.4		0.127	14600	9300
	25	52	15	1	0.6	24	41.6			35.4		0.135	14600	9300
	25	52	15	1	0.6	24	41.6			35.4		0.138	14000	8650
	25	52	15	1	0.6	24	42	44.1	48	35.5	31.8	0.127	14600	9300
	25	62	17	1.1	0.6	27	48.1			39.3		0.223	26000	15000
	25	62	17	1.1	0.6	27	48.1			39.3		0.242	26000	15000
	25	62	17	1.1	0.6	27	48.1			39.3		0.242	24500	13700
	25	62	17	1.1	0.6	27	48.1	50.4	57.1	39.5	36.2	0.231	26000	15000
30	30	55	13	1	0.6	24.3	46.9			40.7		0.109	18300	12500
	30	55	13	1	0.6	24.3	47.1	48.8	53.6	41.3	38.2	0.109	18300	12500
	30	62	16	1	0.6	27	49.8			42.8		0.196	20400	13400
	30	62	16	1	0.6	27	49.8			42.8		0.202	20400	13400
	30	62	16	1	0.6	27	49.8			42.8		0.213	19600	12500
	30	62	16	1	0.6	27	49.8	51.9	57	43.1	39.5	0.203	20400	13400
	30	72	19	1.1	0.6	31	56			46.5		0.341	32500	20000
	30	72	19	1.1	0.6	31	56			46.5		0.362	32500	20000
	30	72	19	1.1	0.6	31	56			46.5		0.37	30500	18300
	30	72	19	1.1	0.6	31	56	58.6	65.9	46.8	42.7	0.341	32500	20000

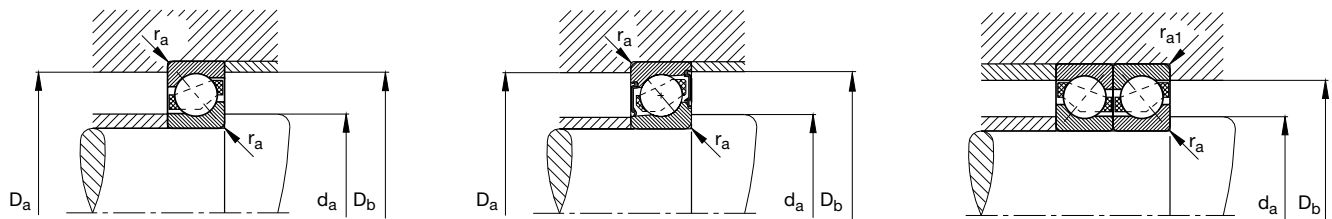

Fatigue limit load C_{ur}	Limiting speed	Reference speed	Designation	Mounting dimensions				
				Bearing	d_a min	D_a max	D_b max	r_a max
N	min^{-1}		FAG	mm				
475	18000		7004B.TVP	23.2	38.8	40	0.6	0.3
475	9500		7004B.2RS.TVP	23.2	38.8	40	0.6	0.3
530	18000	18000	7204B.TVP	25.6	41.4	42.8	1	0.6
530	18000	18000	7204B.JP	25.6	41.4	42.8	1	0.6
530	28000	18000	7204B.MP	25.6	41.4	42.8	1	0.6
530	9000		7204B.2RS.TVP	25.6	41.4	42.8	1	0.6
750	17000	13000	7304B.TVP	27	45	47.8	1	0.6
750	17000	13000	7304B.JP	27	45	47.8	1	0.6
680	28000	14000	7304B.MP	27	45	47.8	1	0.6
750	8500		7304B.2RS.TVP	27	45	47.8	1	0.6
590	16000		7005B.TVP	28.2	43.8	45	0.6	0.3
590	8000		7005B.2RS.TVP	28.2	43.8	45	0.6	0.3
610	16000	16000	7205B.TVP	30.6	46.4	47.8	1	0.6
610	16000	16000	7205B.JP	30.6	46.4	47.8	1	0.6
570	26000	16000	7205B.MP	30.6	46.4	47.8	1	0.6
610	8000		7205B.2RS.TVP	30.6	46.4	47.8	1	0.6
1070	14000	11000	7305B.TVP	32	55	57.8	1	0.6
1070	14000	11000	7305B.JP	32	55	57.8	1	0.6
960	22000	12000	7305B.MP	32	55	57.8	1	0.6
1070	7000		7305B.2RS.TVP	32	55	57.8	1	0.6
780	14000		7006B.TVP	34.6	50.4	51.8	1	0.6
780	6700		7006B.2RS.TVP	34.6	50.4	51.8	1	0.6
960	13000	13000	7206B.TVP	35.6	56.4	57.8	1	0.6
960	13000	13000	7206B.JP	35.6	56.4	57.8	1	0.6
890	20000	14000	7206B.MP	35.6	56.4	57.8	1	0.6
960	6300		7206B.2RS.TVP	35.6	56.4	57.8	1	0.6
1500	11000	10000	7306B.TVP	37	65	67.8	1	0.6
1500	11000	10000	7306B.JP	37	65	67.8	1	0.6
1360	18000	10000	7306B.MP	37	65	67.8	1	0.6
1500	6000		7306B.2RS.TVP	37	65	67.8	1	0.6

Other designs are also available; please contact us.

Single row FAG angular contact ball bearings

X-life

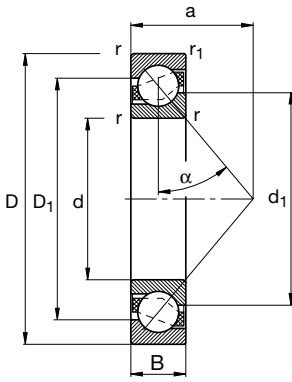

$\alpha = 40^\circ$

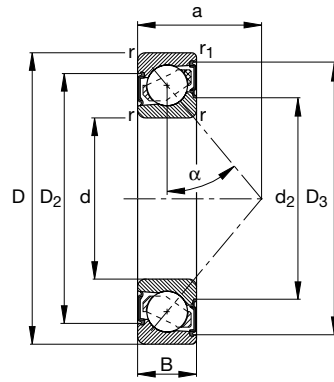

Design 2RS

Single row FAG angular contact ball bearings, d = 35–45 mm

Shaft	Dimensions											Mass ≈ kg	Basic load ratings	
	d	D	B	r min	r ₁ min	a ≈	D ₁ ≈	D ₂ ≈	D ₃ ≈	d ₁ ≈	d ₂ ≈		dyn. C _r	stat. C _{or}
	mm												N	
35	35	62	14	1	0.6	27.3	53.2				46.5	0.14	22400	16000
	35	62	14	1	0.6	27.3	53.3	55	60.4	47	44	0.14	22400	16000
	35	72	17	1.1	0.6	31	57.9			49.5		0.282	27000	18300
	35	72	17	1.1	0.6	31	57.9			49.5		0.30	27000	18300
	35	72	17	1.1	0.6	31	57.9			49.5		0.308	27000	18300
	35	72	17	1.1	0.6	31	57.6	60.2	66.5	50.2	45.8	0.282	27000	18300
	35	80	21	1.5	1	35	63.1			52.7		0.447	39000	25000
	35	80	21	1.5	1	35	63.1			52.7		0.475	39000	25000
35	80	21	1.5	1	35	63.1			52.7		0.48	39000	25000	
40	40	68	15	1	0.6	30.2	58.6			51.3		0.17	26000	18600
	40	68	15	1	0.6	30.2	58.8	60.5	66.3	51.9	48.8	0.17	26000	18600
	40	80	18	1.1	0.6	34	64.7			55.7		0.367	32000	23200
	40	80	18	1.1	0.6	34	64.7			55.7		0.387	32000	23200
	40	80	18	1.1	0.6	34	64.7			55.7		0.401	32000	23200
	40	80	18	1.1	0.6	34	64.4	67	73.8	56.4	52	0.367	32000	23200
	40	90	23	1.5	1	39	71.7			59.2		0.61	50000	32500
	40	90	23	1.5	1	39	71.7			59.2		0.646	50000	32500
	40	90	23	1.5	1	39	71.7			59.2		0.666	50000	32500
40	90	23	1.5	1	39	71.3	73.9	83.3	60	55.6	0.61	50000	32500	
45	45	85	19	1.1	0.6	37	70			60.5		0.405	36000	26500
	45	85	19	1.1	0.6	37	70			60.5		0.428	36000	26500
	45	85	19	1.1	0.6	37	70			60.5		0.445	36000	26500
	45	100	25	1.5	1	43	79.8			66.7		0.813	60000	40000
	45	100	25	1.5	1	43	79.8			66.7		0.878	60000	40000
	45	100	25	1.5	1	43	79.8			66.7		0.890	60000	40000

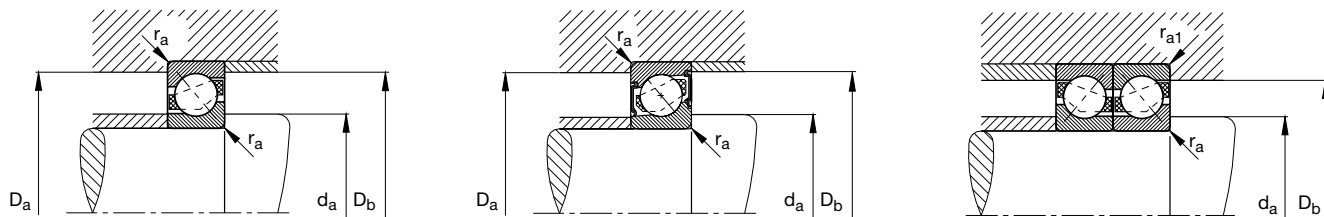

Fatigue limit load C_{ur}	Limiting speed	Reference speed	Designation	Mounting dimensions				
				Bearing	d_a min	D_a max	D_b max	r_a max
N	min^{-1}		FAG	mm				
1010	12000		7007B.TVP	39.6	57.4	58.8	1	0.6
1010	6000		7007B.2RS.TVP	39.6	57.4	58.8	1	0.6
1300	11000	12000	7207B.TVP	42	65	67.8	1	0.6
1300	11000	12000	7207B.JP	42	65	67.8	1	0.6
1300	18000	12000	7207B.MP	42	65	67.8	1	0.6
1300	5600		7207B.2RS.TVP	42	65	67.8	1	0.6
1880	9500	9000	7307B.TVP	44	71	74.4	1.5	1
1880	9500	9000	7307B.JP	44	71	74.4	1.5	1
1880	15000	9500	7307B.MP	44	71	75	1.5	1
1190	10000		7008B.TVP	44.6	63.4	64.8	1	0.6
1190	5300		7008B.2RS.TVP	44.6	63.4	64.8	1	0.6
1610	9500	10000	7208B.TVP	47	73	75.8	1	0.6
1610	9500	10000	7208B.JP	47	73	75.8	1	0.6
1610	15000	10000	7208B.MP	47	73	75.8	1	0.6
1610	5000		7208B.2RS.TVP	47	73	75.8	1	0.6
2340	8500	8500	7308B.TVP	49	81	84.4	1.5	1
2340	8500	8500	7308B.JP	49	81	84.4	1.5	1
2340	14000	8500	7308B.MP	49	81	84.4	1.5	1
2340	4500		7308B.2RS.TVP	49	81	84.4	1.5	1
1840	8500	9500	7209B.TVP	52	78	80.8	1	0.6
1840	8500	9500	7209B.JP	52	78	80.8	1	0.6
1840	14000	10000	7209B.MP	52	78	80.8	1	0.6
2950	7500	7500	7309B.TVP	54	91	94.4	1.5	1
2950	7500	7500	7309B.JP	54	91	95	1.5	1
2950	12000	8000	7309B.MP	54	91	94.4	1.5	1

Other designs are also available; please contact us.

Single row FAG angular contact ball bearings

X-life

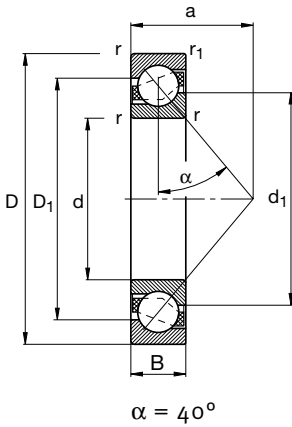

Single row FAG angular contact ball bearings, d = 50–65 mm

Shaft	Dimensions								Mass ≈ kg	Basic load ratings	
	d	D	B	r min	r ₁ min	a ≈	D ₁ ≈	d ₁ ≈		dyn. C _r N	stat. C _{or}
	mm										
50	50	90	20	1.1	0.6	39	74.8	66.2	0.458	37500	28500
	50	90	20	1.1	0.6	39	74.8	66.2	0.493	37500	28500
	50	90	20	1.1	0.6	39	74.8	66.2	0.503	37500	28500
	50	110	27	2	1	47	87.6	73.1	1.05	69500	47500
	50	110	27	2	1	47	87.6	73.1	1.13	69500	47500
	50	110	27	2	1	47	87.6	73.1	1.17	69500	47500
55	55	100	21	1.5	1	43	83	72.6	0.604	46500	36000
	55	100	21	1.5	1	43	83	72.6	0.645	46500	36000
	55	100	21	1.5	1	43	83	72.6	0.662	46500	36000
	55	120	29	2	1	51	95.3	80.3	1.38	78000	56000
	55	120	29	2	1	51	95.3	80.3	1.46	78000	56000
	55	120	29	2	1	51	95.3	80.3	1.51	78000	56000
60	60	110	22	1.5	1	47	91.1	79.5	0.78	56000	44000
	60	110	22	1.5	1	47	91.1	79.5	0.847	56000	44000
	60	110	22	1.5	1	47	91.1	79.5	0.857	56000	44000
	60	130	31	2.1	1.1	55	103.4	87.3	1.72	90000	65500
	60	130	31	2.1	1.1	55	103.4	87.3	1.74	90000	65500
	60	130	31	2.1	1.1	55	103.4	87.3	1.86	90000	65500
65	65	120	23	1.5	1	50.5	98.9	86	1	64000	53000
	65	120	23	1.5	1	50.5	98.9	86	1.08	64000	53000
	65	120	23	1.5	1	50.5	98.9	86	1.09	61000	49000
	65	140	33	2.1	1.1	60	112	95	2.12	102000	75000
	65	140	33	2.1	1.1	60	112	95	2.22	102000	75000
	65	140	33	2.1	1.1	60	112	95	2.32	102000	75000

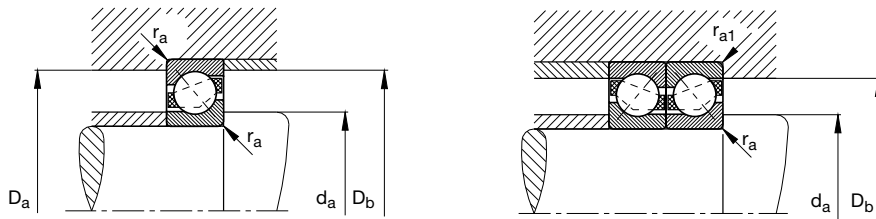

Fatigue limit load C_{ur}	Limiting speed	Reference speed	Designation	Mounting dimensions				
				Bearing	d_a min mm	D_a max	D_b max	r_a max
N	min^{-1}	N	FAG					
1950	8000	9000	7210B.TVP	57	83	85.8	1	0.6
1950	8000	9000	7210B.JP	57	83	85.8	1	0.6
1950	13000	9000	7210B.MP	57	83	85.8	1	0.6
3400	7000	7000	7310B.TVP	61	99	104.4	2	1
3400	7000	7000	7310B.JP	61	99	104.4	2	1
3400	11000	7000	7310B.MP	61	99	104.4	2	1
2600	7000	8500	7211B.TVP	64	91	94.4	1.5	1
2600	7000	8500	7211B.JP	64	91	94.4	1.5	1
2600	11000	8500	7211B.MP	64	91	94.4	1.5	1
4150	6300	6700	7311B.TVP	66	109	114.4	2	1
4150	6300	6700	7311B.JP	66	109	114.4	2	1
4150	10000	6700	7311B.MP	66	109	114.4	2	1
3250	6300	7500	7212B.TVP	69	101	104.4	1.5	1
3250	6300	7500	7212B.JP	69	101	104.4	1.5	1
3250	10000	7500	7212B.MP	69	101	104.4	1.5	1
4700	5600	6300	7312B.TVP	72	118	123	2.1	1
4700	5600	6300	7312B.JP	72	118	123	2.1	1
4700	9000	6300	7312B.MP	72	118	123	2.1	1
3750	6000	7000	7213B.TVP	74	111	114.4	1.5	1
3750	6000	7000	7213B.JP	74	111	114.4	1.5	1
3550	9500	7000	7213B.MP	74	111	114.4	1.5	1
5500	5300	6000	7313B.TVP	77	128	133	2.1	1
5500	5300	6000	7313B.JP	77	128	133	2.1	1
5500	8500	6000	7313B.MP	77	128	133	2.1	1

Other designs are also available; please contact us.

Single row FAG angular contact ball bearings

X-life

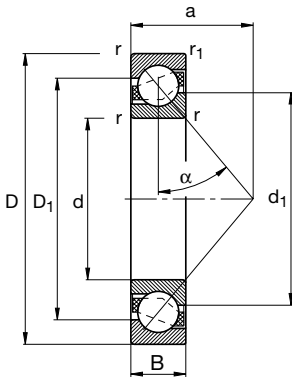

$$\alpha = 40^\circ$$

Single row FAG angular contact ball bearings, d = 70–85 mm

Shaft	Dimensions								Mass ≈ kg	Basic load ratings	
	d	D	B	r min	r ₁ min	a ≈	D ₁ ≈	d ₁ ≈		dyn. C _r N	stat. C _{0r} N
70	70	125	24	1.5	1	53	104.7	91	1.08	69500	58500
	70	125	24	1.5	1	53	104.7	91	1.17	69500	58500
	70	125	24	1.5	1	53	104.7	91	1.18	65500	54000
	70	150	35	2.1	1.1	64	120.1	101.9	2.58	114000	86500
	70	150	35	2.1	1.1	64	120.1	101.9	2.76	114000	86500
	70	150	35	2.1	1.1	64	120.1	101.9	2.82	114000	86500
75	75	130	25	1.5	1	56	109.2	96.5	1.16	68000	58500
	75	130	25	1.5	1	56	109.2	96.5	1.25	68000	58500
	75	130	25	1.5	1	56	109.2	96.5	1.29	68000	58500
	75	160	37	2.1	1.1	68	128.5	108.8	3.1	127000	100000
	75	160	37	2.1	1.1	68	128.5	108.8	3.29	127000	100000
	75	160	37	2.1	1.1	68	128.5	108.8	3.39	127000	100000
80	80	140	26	2	1	59	117.8	102.9	1.42	80000	69500
	80	140	26	2	1	59	117.8	102.9	1.53	80000	69500
	80	140	26	2	1	59	117.8	102.9	1.58	80000	69500
	80	170	39	2.1	1.1	72	136.7	115.7	3.66	140000	114000
	80	170	39	2.1	1.1	72	136.7	115.7	3.86	140000	114000
	80	170	39	2.1	1.1	72	136.7	115.7	4.02	140000	114000
85	85	150	28	2	1	63	125	110.6	1.82	90000	80000
	85	150	28	2	1	63	125	110.6	1.94	90000	80000
	85	150	28	2	1	63	125	110.6	1.98	86500	75000
	85	180	41	3	1.1	76	144	122	4.27	150000	127000
	85	180	41	3	1.1	76	144	122	4.4	150000	127000
	85	180	41	3	1.1	76	144	122	4.7	150000	127000

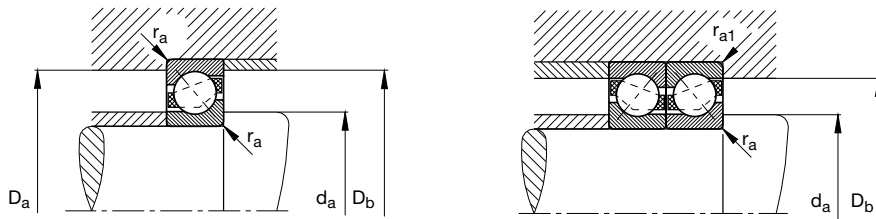

Fatigue limit load C_{ur}	Limiting speed	Reference speed	Designation	Mounting dimensions				
				Bearing	d_a min mm	D_a max	D_b max	r_a max
N	min^{-1}		FAG					
4250	5600	6700	7214B.TVP	79	116	119.4	1.5	1
4250	5600	6700	7214B.JP	79	116	119.4	1.5	1
4000	9000	6700	7214B.MP	79	116	119.4	1.5	1
6100	5000	5600	7314B.TVP	82	138	143	2.1	1
6100	5000	5600	7314B.JP	82	138	143	2.1	1
6100	8000	5600	7314B.MP	82	138	143	2.1	1
4200	5300	6700	7215B.TVP	84	121	124.4	1.5	1
4200	5300	6700	7215B.JP	84	121	124.4	1.5	1
4200	8500	6700	7215B.MP	84	121	124.4	1.5	1
6700	4500	5300	7315B.TVP	87	148	153	2.1	1
6700	4500	5300	7315B.JP	87	148	153	2.1	1
6700	7000	5300	7315B.MP	87	148	153	2.1	1
4700	5000	6000	7216B.TVP	91	129	134.4	2	1
4700	5000	6000	7216B.JP	91	129	134.4	2	1
4700	8000	6000	7216B.MP	91	129	134.4	2	1
7600	4300	4800	7316B.TVP	92	158	163	2.1	1
7600	4300	4800	7316B.JP	92	158	163	2.1	1
7600	7000	4800	7316B.MP	92	158	163	2.1	1
5400	4500	6000	7217B.TVP	96	139	144.4	2	1
5400	4500	6000	7217B.JP	96	139	144.4	2	1
5100	7000	6000	7217B.MP	96	139	144.4	2	1
8200	4000	4500	7317B.TVP	99	166	173	2.5	1
8200	4000	4500	7317B.JP	99	166	173	2.5	1
8200	6300	4500	7317B.MP	99	166	173	2.5	1

Other designs are also available; please contact us.

Single row FAG angular contact ball bearings

X-life

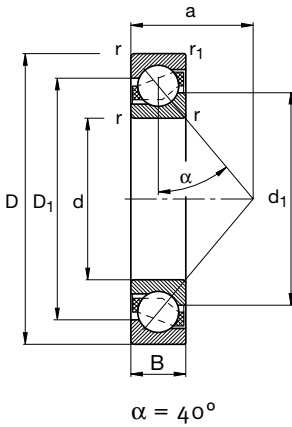

Single row FAG angular contact ball bearings, d = 90–105 mm

Shaft	Dimensions								Mass ≈ kg	Basic load ratings	
	d	D	B	r min	r ₁ min	a ≈	D ₁ ≈	d ₁ ≈		dyn. C _r	stat. C _{or}
	mm									N	
90	90	160	30	2	1	67	133.4	117.5	2.21	106000	93000
	90	160	30	2	1	67	133.4	117.5	2.38	106000	93000
	90	160	30	2	1	67	133.4	117.5	2.42	106000	93000
	90	190	43	3	1.1	80	153	129.7	5	160000	140000
	90	190	43	3	1.1	80	153	129.7	5.14	160000	140000
	90	190	43	3	1.1	80	153	129.7	5.52	160000	140000
95	95	170	32	2.1	1.1	72	142	124.9	2.64	116000	100000
	95	170	32	2.1	1.1	72	142	124.9	2.64	116000	100000
	95	170	32	2.1	1.1	72	142	124.9	2.94	116000	100000
	95	200	45	3	1.1	84	160.1	136.7	5.78	173000	153000
	95	200	45	3	1.1	84	160.1	136.7	5.93	173000	153000
	95	200	45	3	1.1	84	160.1	136.7	6.38	173000	153000
100	100	180	34	2.1	1.1	76	149.6	131.9	3.17	129000	114000
	100	180	34	2.1	1.1	76	149.6	131.9	3.45	137000	122000
	100	180	34	2.1	1.1	76	149.6	131.9	3.52	129000	114000
	100	215	47	3	1.1	90	172.3	145.8	7.16	193000	180000
	100	215	47	3	1.1	90	172.3	145.8	7.38	193000	180000
	100	215	47	3	1.1	90	172.3	145.8	7.9	193000	180000
105	105	190	36	2.1	1.1	80	157.7	138.2	4.18	143000	129000
	105	225	49	3	1.1	94	179.6	153.5	9	200000	193000

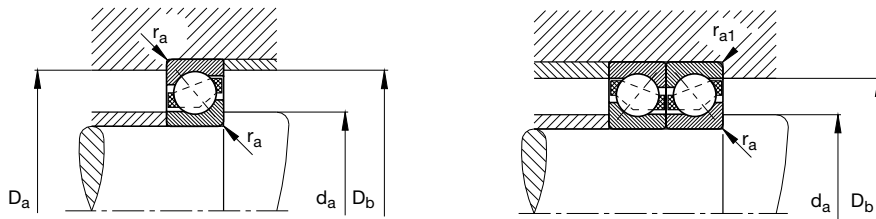

Fatigue limit load C_{ur}	Limiting speed	Reference speed	Designation	Mounting dimensions					
				Bearing	d_a min mm	D_a max	D_b max	r_a max	r_{a1} max
N	min^{-1}	N	FAG						
6000	4300	5600	7218B.TVP		101	149	154.4	2	1
6000	4300	5600	7218B.JP		101	149	154.4	2	1
6000	7000	5600	7218B.MP		101	149	154.4	2	1
8900	3800	4300	7318B.TVP		104	176	183	2.5	1
8900	3800	4300	7318B.JP		104	176	183	2.5	1
8900	6000	4300	7318B.MP		104	176	183	2.5	1
6300	4000	5300	7219B.TVP		107	158	163	2.1	1
6300	4000	5300	7219B.JP		107	158	163	2.1	1
6300	6300	5300	7219B.MP		107	158	163	2.1	1
9400	3800	4000	7319B.TVP		109	186	193	2.5	1
9400	3800	4000	7319B.JP		109	186	193	2.5	1
9400	6000	4000	7319B.MP		109	186	193	2.5	1
7200	3800	5000	7220B.TVP		112	168	173	2.1	1
7600	3800	5000	7220B.JP		112	168	173	2.1	1
7200	6000	5000	7220B.MP		112	168	173	2.1	1
10700	3600	3600	7320B.TVP		114	201	208	2.5	1
10700	3600	3600	7320B.JP		114	201	208	2.5	1
10700	5600	3600	7320B.MP		114	201	208	2.5	1
8000	6000	4800	7221B.MP		117	178	183	2.1	1
11300	5300	3400	7321B.MP		119	211	218	2.5	1

Other designs are also available; please contact us.

Single row FAG angular contact ball bearings

X-life

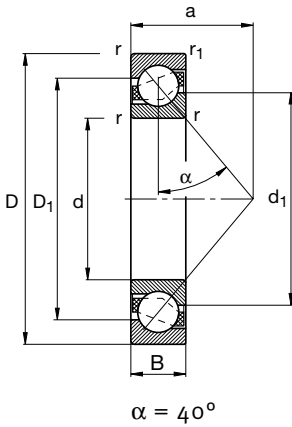

Single row FAG angular contact ball bearings, d = 110–150 mm

Shaft	Dimensions								Mass ≈ kg	Basic load ratings	
	d	D	B	r min	r ₁ min	a ≈	D ₁ ≈	d ₁ ≈		dyn. C _r N	stat. C _{0r} N
	mm										
110	110	200	38	2.1	1.1	84	165.7	144.9	4.44	153000	143000
	110	200	38	2.1	1.1	84	165.7	144.9	4.7	153000	143000
	110	200	38	2.1	1.1	84	165.7	144.9	4.92	153000	143000
	110	240	50	3	1.1	98	191.5	161.9	9.74	224000	224000
	110	240	50	3	1.1	98	191.5	161.9	9.97	224000	224000
	110	240	50	3	1.1	98	191.5	161.9	10.7	224000	224000
120	120	215	40	2.1	1.1	90	179.5	157.2	5.31	166000	160000
	120	215	40	2.1	1.1	90	179.5	157.2	5.9	166000	160000
	120	260	55	3	1.1	107	207.7	175.9	12.5	250000	260000
	120	260	55	3	1.1	107	207.7	175.9	13.7	250000	260000
130	130	230	40	3	1.1	96	191.8	169.2	6.12	186000	190000
	130	230	40	3	1.1	96	191.8	169.2	6.73	186000	190000
	130	280	58	4	1.5	115	222.5	188.5	15.1	275000	300000
	130	280	58	4	1.5	115	222.5	188.5	16.7	275000	300000
140	140	250	42	3	1.1	103	207.5	183.5	8.55	196000	212000
150	150	270	45	3	1.1	111	223.5	197.5	10.9	224000	255000

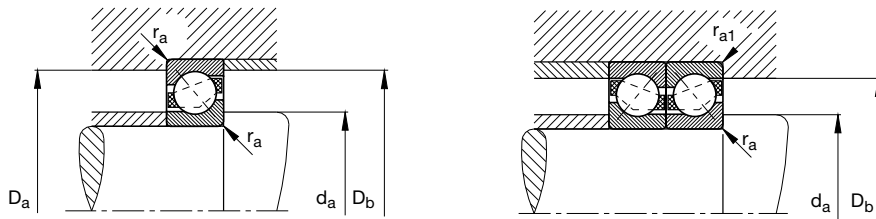

Fatigue limit load C_{ur}	Limiting speed	Reference speed	Designation	Mounting dimensions					
				Bearing	d_a min mm	D_a max	D_b max	r_a max	r_{a1} max
N	min^{-1}	N	FAG						
8400	3600	4500	7222B.TVP		122	188	193	2.1	1
8400	3600	4500	7222B.JP		122	188	193	2.1	1
8400	5600	4500	7222B.MP		122	188	193	2.1	1
12600	3400	3200	7322B.TVP		124	226	233	2.5	1
12600	3400	3200	7322B.JP		124	226	233	2.5	1
12600	3400	3200	7322B.MP		124	226	233	2.5	1
9400	3400	4300	7224B.TVP		132	203	208	2.1	1
9400	5300	4300	7224B.MP		132	203	208	2.1	1
14100	3200	3000	7324B.TVP		134	246	253	2.5	1
14100	5000	3000	7324B.MP		134	246	253	2.5	1
10400	3200	3800	7226B.TVP		144	216	223	2.5	1
10400	5000	3800	7226B.MP		144	216	223	2.5	1
15600	3000	2600	7326B.TVP		147	263	271	3	1.5
15600	4800	2600	7326B.MP		147	263	271	3	1.5
11300	4800	3400	7228B.MP		154	236	243	2.5	1
13000	4500	3000	7230B.MP		164	256	263	2.5	1

Other designs are also available; please contact us.

Notes

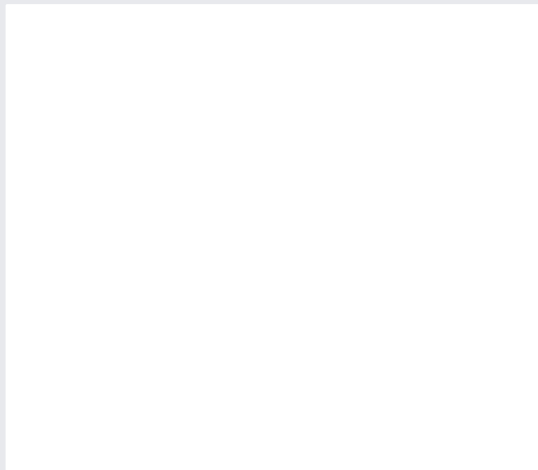

Every care has been taken to ensure the correctness of the information contained in this publication but no liability can be accepted for any errors or omissions. We reserve the right to make changes in the interest of technical progress.

© by FAG 2004.

This publication or parts thereof may not be reproduced without our permission.

WL 43 166/2 EA